

SPECIFICATIONS:

- Voltage Rating: 150V AC/DC
- Current Rating: 1A AC/DC
- Withstanding Voltage: 500V AC/Minute
- Temperature Range: -25°C~+85°C
- Insulation Resistance: 500MΩ Min.
- Contact Resistance: 30mΩ Max.
- Applicable Wire Range: AWG#26~30.

Assembly Layout:

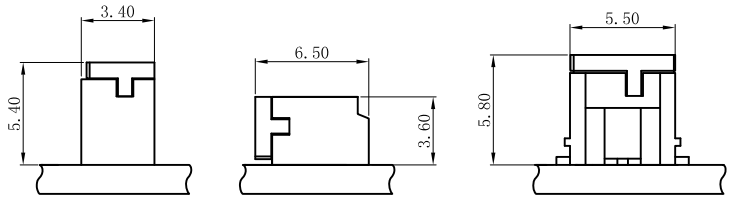

A1252H-2NP-N0GY

1.25mm Pitch Dual Row Housing

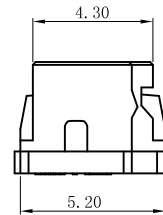
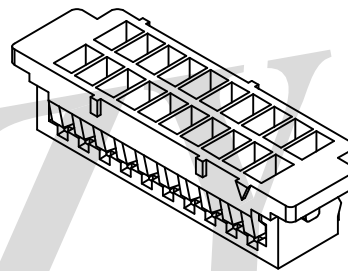
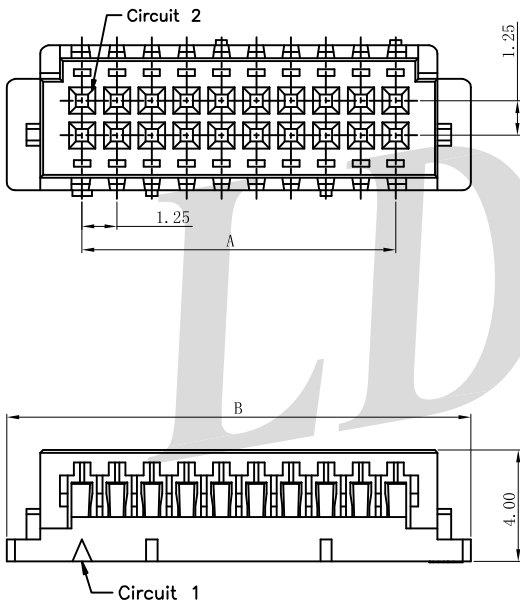

Reference Informations:

- *Material:
- Housing: PA66 UL94V-0/Gray
- *Suitable LDZY A1252 series Terminal
- *Mates with LDZY A1252 series Wafer

Ordering Information & Dimensions

PART NO.	Dimensions (mm)	
	A	B
2*05P	5.00	10.40
2*06P	6.25	11.65
2*07P	7.50	12.90
2*10P	11.25	16.65
2*15P	17.50	22.90
2*18P	21.25	25.40
2*20P	23.75	29.15
2*21P	25.00	30.40
2*25P	30.00	35.40

A1252H-NP-N0GY

1.25mm Pitch Single Row Housing

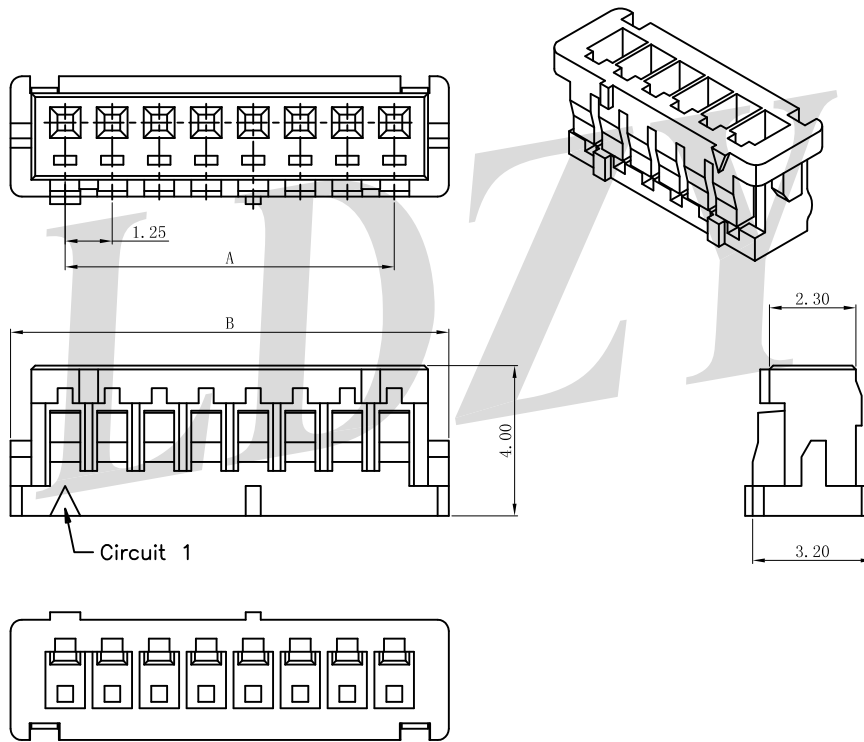

Reference Informations:

*Material:

Housing: PA66 UL94V-0/Gray

*Suitable LDZY A1252 series Terminal

*Mates with LDZY A1252 series Wafer

Ordering Information & Dimensions

Poles	Dimensions (mm)	
	A	B
2	1.25	4.15
3	2.50	5.40
4	3.75	6.65
5	5.00	7.90
6	6.25	9.15
7	7.50	10.40
8	8.75	11.65
9	10.00	12.90
10	11.25	14.15
12	13.75	16.65
13	15.00	17.90
14	16.25	19.15
15	17.50	20.40

A1252TF-PT1

1.25mm Pitch Terminal

Reference Informations:

*Material: Phosphor Bronze/Tin-plated

*Mates with LDZY A1252 series Housing

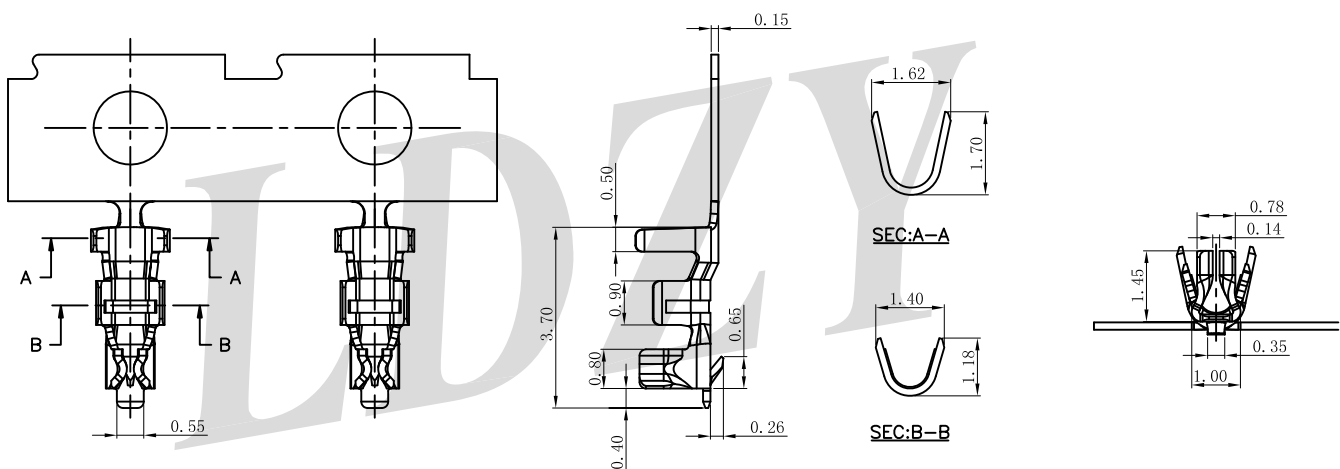

Ordering Information & Specifications

Part No	Wire Range	Insulation O.D.	Material	Finish	Qty/reel
A1252TF-PT1	AWG#26-#30	1.00mm(max)	Phosphor Bronze	Tin-plated	20,000pcs

A1252WV-NP-NONAT

1.25mm Pitch SMT Single Row Wafer

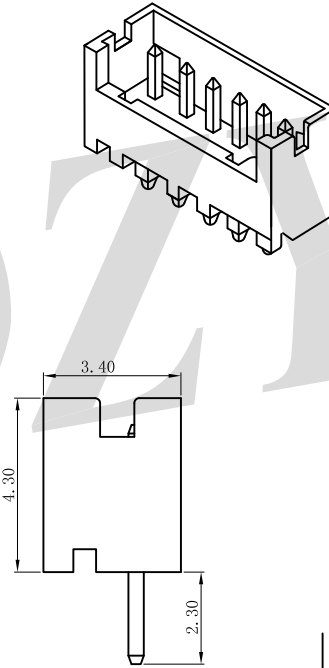
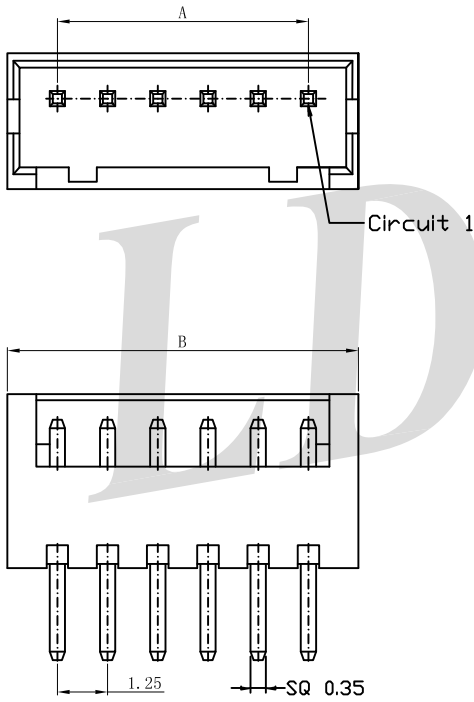

Reference Informations:

*Material:

PIN: Brass/Gold-flash

Wafer: PA66,UL94V-0 / Natrual

*Suitable LDZY A1252 series Housing

Ordering Information & Dimensions

Poles	Dimensions (mm)	
	A	B
2	1.25	3.75
3	2.50	5.00
4	3.75	6.25
5	5.00	7.50
6	6.25	8.75
7	7.50	10.00
8	8.75	11.25
9	10.00	12.50
10	11.25	13.75
11	12.50	15.00
12	13.75	16.25
13	15.00	17.50
14	16.25	18.75
15	17.50	20.00

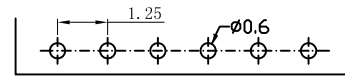

Recommand PCB Layout

A1252WR-NP-NONAT

1.25mm Pitch Single Row Wafer

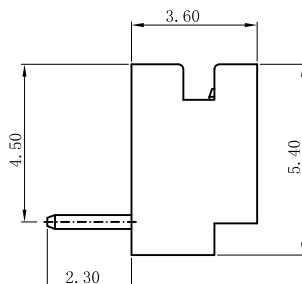
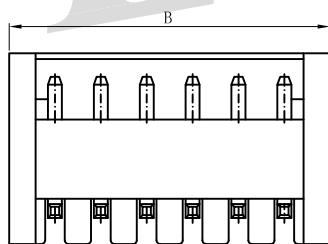
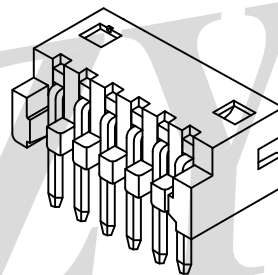
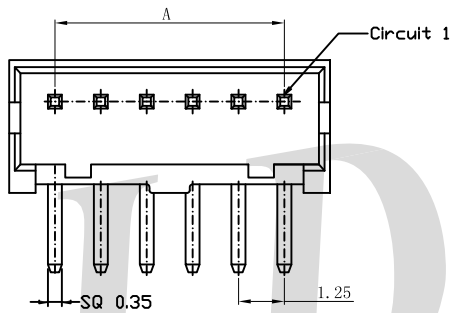

Reference Informations:

*Material:

PIN: Brass/Tin-plated

Wafer: PA66,UL94V-0 / Natrual

*Suitable LDZY A1252 series Housing

Ordering Information & Dimensions

Poles	Dimensions (mm)	
	A	B
2	1.25	3.75
3	2.50	5.00
4	3.75	6.25
5	5.00	7.50
6	6.25	8.75
7	7.50	10.00
8	8.75	11.25
9	10.00	12.50
10	11.25	13.75
11	12.50	15.00
12	13.75	16.25
13	15.00	17.50
14	16.25	18.75
15	17.50	20.00

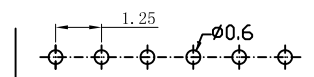

Recommand PCB Layout

A1252WVS-2NP-6TNAT

1.25mm Pitch 180° SMT Single Row Wafer

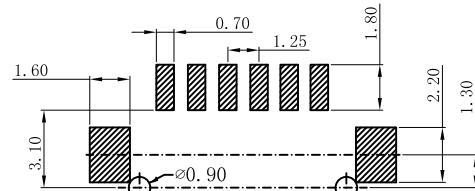
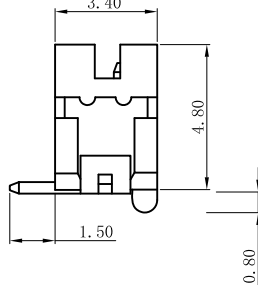
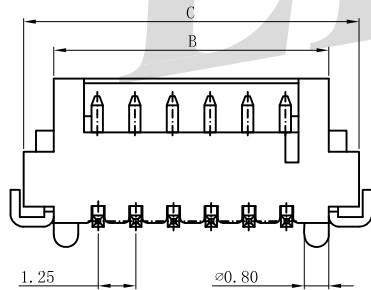
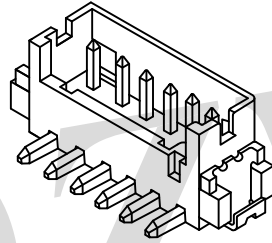
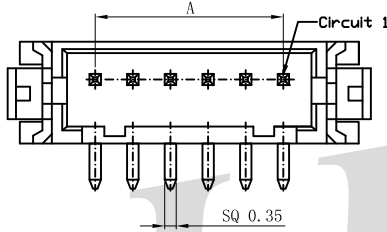

Recommad PCB Layout

Reference Informations:

*Material:

PIN: Brass/Tin-plated

Solder Tabs: Phosphor Bronze/Tin-plated

Wafer: PA6T,UL94V-0 / Natrual

*Suitable LDZY A1252 series Housing

Ordering Information & Dimensions

Poles	Dimensions (mm)		
	A	B	C
2	1.25	4.15	6.25
3	2.50	5.40	7.50
4	3.75	6.65	8.75
5	5.00	7.90	10.00
6	6.25	9.15	11.25
7	7.50	10.40	12.50
8	8.75	11.65	13.75
9	10.00	12.90	15.00
10	11.25	14.15	16.25
11	12.50	15.40	17.50
12	13.75	16.65	18.75
13	15.00	17.90	20.00
14	16.25	19.15	21.25
15	17.50	20.40	22.50

A1252WRS-2NP-6TNAT

1.25mm Pitch 90° SMT Single Row Wafer

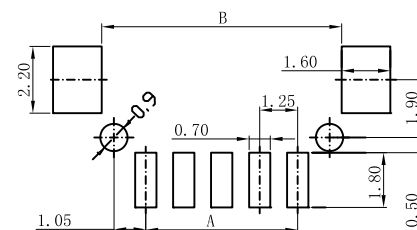
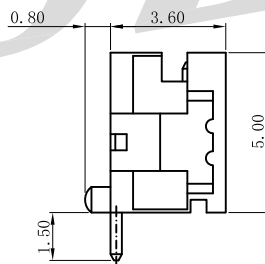
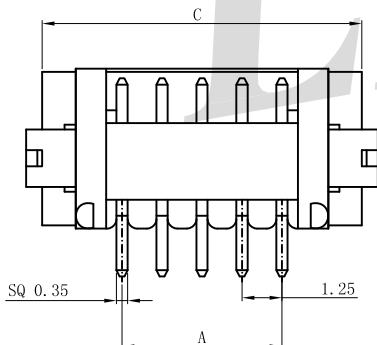
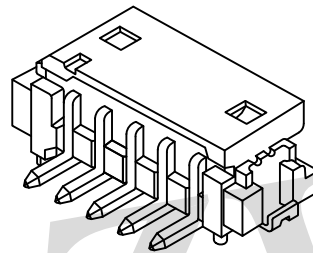
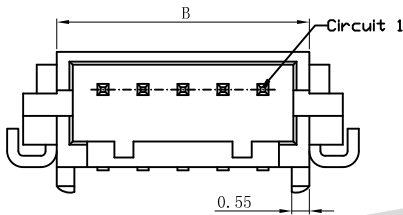

Recommad PCB Layout

Reference Informations:

*Material:

PIN: Brass/Tin-plated

Solder Tabs: **Phosphor Bronze**/Tin-plated

Wafer: PA6T,UL94V-0 / Natrual

*Suitable LDZY A1252 series Housing

Ordering Information & Dimensions

Poles	Dimensions (mm)		
	A	B	C
2	1.25	4.15	6.25
3	2.50	5.40	7.50
4	3.75	6.65	8.75
5	5.00	7.90	10.00
6	6.25	9.15	11.25
7	7.50	10.40	12.50
8	8.75	11.65	13.75
9	10.00	12.90	15.00
10	11.25	14.15	16.25
11	12.50	15.40	17.50
12	13.75	16.65	18.75
13	15.00	17.90	20.00
14	16.25	19.15	21.25
15	17.50	20.40	22.50

A1252WVS-2NP-9TNAG

1.25mm Pitch 180° SMT Dual Row Wafer

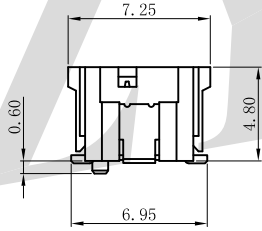
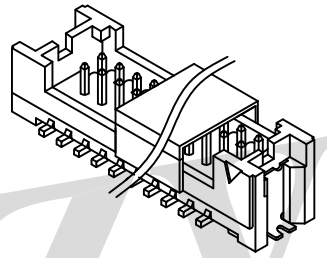
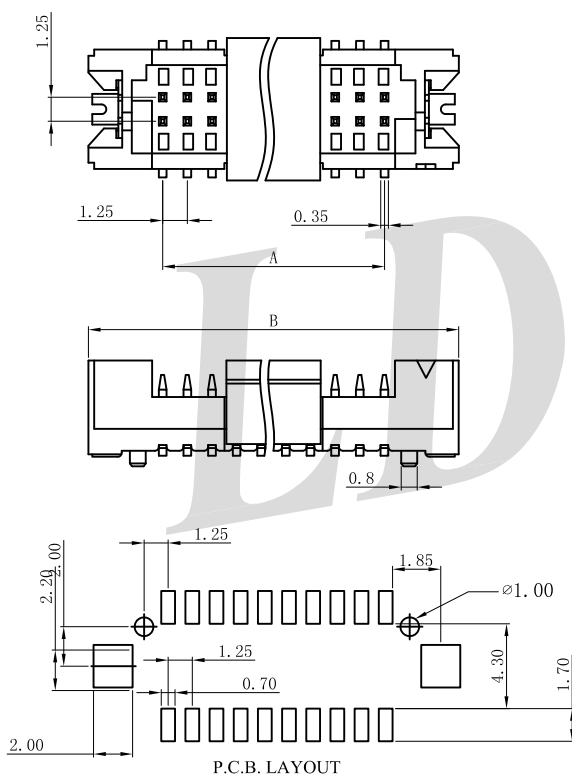

Reference Informations:

*Material:

PIN: Brass/Gold-flash

Solder Tabs: Brass/Gold-flash

Wafer: PA9T,UL94V-0 / Natrual

*Suitable LDZY A1252 series Housing

Ordering Information & Dimensions

Poles	Part No	Dimensions (mm)	
		A	B
10	2*05P	5.00	12.50
12	2*06P	6.25	13.75
14	2*07P	7.50	15.00
20	2*10P	11.25	18.75
24	2*12P	13.75	21.25
30	2*15P	17.50	25.00
40	2*20P	23.75	31.25
50	2*25P	30.00	37.50